

# USER MANUAL

MM6500 MULTIMETER

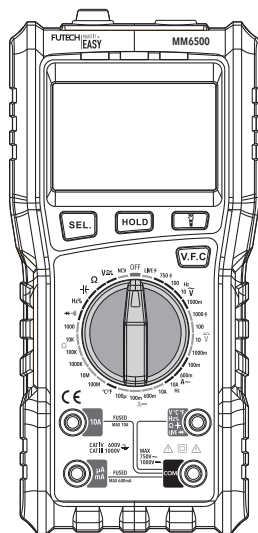

EN ENGLISH

Manual in your  
language?

Check the back cover

**FUTECH**  
MAKE IT  
**EASY**

## OVERVIEW

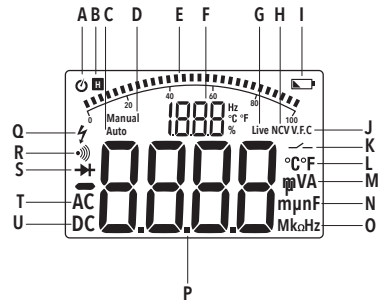
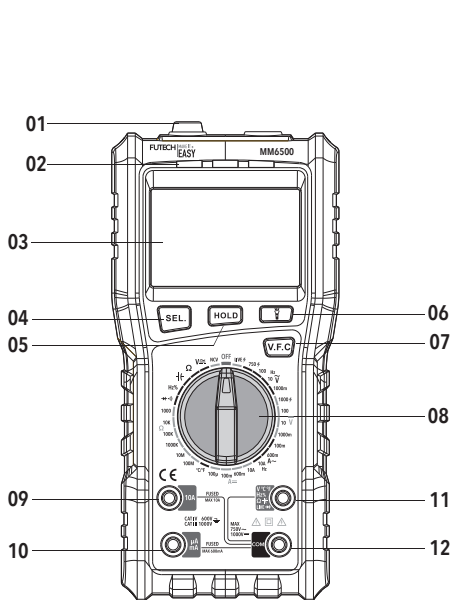

### ■ DEVICE

- 01 Non-contact voltage sensor
- 02 Non-contact voltage indicator light
- 03 LCD Display
- 04 Select button
- 05 HOLD button
- 06 Flashlight button
- 07 VFC button
- 08 Range rotary knob
- 09 10A terminal
- 10 mA/μA terminal
- 11 VΩ → ← ⚡ Live Hz % °C/°F terminal
- 12 COM terminal

## ■ DISPLAY

- A Automatic shutdown indicator
- B Hold reading indicator
- C Automatic range mode indicator
- D Manual range mode indicator
- E % of max range measured
- F Hz - °C/°F - % Display line
- G Live fire test indicator
- H Non-contact AC Voltage detection mode indicator
- I Low battery indicator
- J Frequency conversion/Voltage measurement
- K Blown fuse tube indicator
- L °C/°F unit selection mode
- M (m)V - (m)A -  $\mu$ A unit indicator
- N (m, $\mu$ ,n)F unit indicator
- O (M,k) $\Omega$  / (M,k)Hz
- P Main display line
- Q High voltage warning indicator
- R Continuity test mode indicator
- S Diode test mode indicator
- T AC input indicator
- U DC input indicator

## SAFETY

Please read the safety instructions provided in the separate booklet provided with the device before using.

- Do not exceed 1000V when making category III measurements, or 600V when making category IV measurements.
- For all DC functions; to avoid the risk of electrocution due to incorrect readings, use the AC function first to confirm the presence of ANY AC voltage. Then, choose a DC voltage range equal or greater than the AC voltage.
- The input value must not exceed the input limit specified for each range to prevent damage to the instrument.

In the  $\mu$ A and mA mode, if the fuse tube is blown, the screen will display FUSE and the blown fuse indicator [K]. This means the fuse tube is disconnected after the measurement probe is inserted into the  $\mu$ A/mA terminal [10]. If this happens, the fuse tube needs to be replaced before measuring can be continued. The same prompt can also be received in 10A mode.

### NOTE

Using the device near large electromagnetic interference, the reading of the instrument will be unstable. A large error may then occur.

## BATTERY

This laser device uses 2x AA Batteries.

## NOTE

When not in use for a long time, please remove the battery and avoid storing it in a place with high temperature and humidity.

## FIRST TIME USAGE

Remove all protection foils.

### \_\_\_ INSTALLING THE BATTERY

- Open the battery cover by unscrewing the singular screw.
- Insert 2x AA batteries while respecting the correct polarities
- Close the battery cover and screw it back on.

## USE

### ■ HOLDING A MEASUREMENT

The Hold reading mode allows you to keep the current reading on the display. The mode can be exited by either changing the measurement function gear or by pressing the HOLD button again. to enter HOLD mode:

- Press the HOLD button [05] the reading will be held and the indicator [B] will show on the display [03].
- Press the HOLD button [05] again to return the instrument to it's normal measurement state.



**HOLD**

### ■ LIGHTING FUNCTION

The device has a built-in flashlight to allow for operations in darker lighting conditions. To turn on the flashlight:

- Press the flashlight button [06] once to turn on the light
- Press the flashlight button [06] once more to turn the flashlight off again.



### ■ FREQUENCY CONVERSION VOLTAGE MEASUREMENT

In the automatic AC/DC mode, press the Select button [04] to switch between AC and DC measurement modes. Next, you can press the VFC Button [07] to enter frequency conversion voltage measurement mode, which can measure the frequency conversion voltage stably.

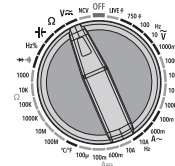

### ■ MEASURING AC AND DC VOLTAGES

## NOTE

ANY voltages above 1000V DC or 750V AC cannot be measured to prevent electric shock and/or damage to the instrument.

### — AUTOMATIC RANGE

- Rotate the rotary knob [08] to face the automatic range measurement mode
- press the Select button [04] to switch between AC and DC measurement.

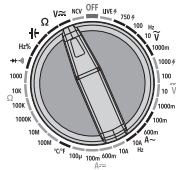

### — MANUAL RANGE

- Rotate the rotary knob [08] to select a range between 1000V and 1000mV AC or DC

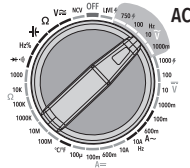
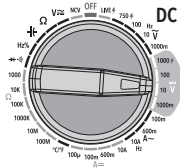

- Connect the black measurement probe to the COM input terminal [12] and the red probe to the V input terminal [11].

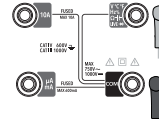

- Use the other ends on the measurement probes to measure the voltage value of the circuit under test.
- The measured voltage value is displayed on the LCD display [03] on the main display line [P].
- If the manual voltage mode is used, the knob [08] needs to be rotated to the appropriate range. Measuring AC will display both voltage and frequency. Measuring DC will display both voltage and the polarity of the measurement

### NOTE

While measuring AC voltage, press the V.F.C. button [07] to measure AC frequency conversion voltage.

The AC voltage measured is the true RMS. For sine waves and other waveforms such as square waves, triangle waves and staircase waveforms, these measurements are accurate.

## ■ MEASURING RESISTANCE

### NOTE

To avoid damage to the instrument or the device under test, turn off all power to the circuit under test and fully discharge all high-voltage capacitors before measuring resistance.

### — AUTOMATIC RANGE

- Rotate the rotary knob [08] to face the automatic range measurement mode.

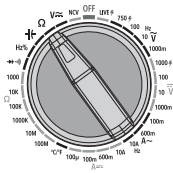

### — MANUAL RANGE

- Or using the rotary knob [08] select a range between 1000Ω and 100MΩ.

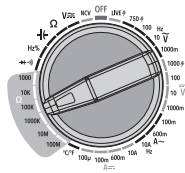

- Connect the black measurement probe to the COM input terminal [12] and the red probe to the Ω input terminal [11].

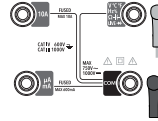

- Use the other ends on the measurement probes to measure the resistance value of the circuit under test.
- The measured resistance value is displayed on the LCD display [03] on the main display line [P] if the manual resistance mode is used, the knob [08] needs to be rotated to the appropriate range to read the correct value.

### NOTE

In the 100MΩ range, it takes a few moments to stabilize the reading. This is normal for high resistance measurements.

The measured resistance value on the circuit will usually differ from the rated value of the resistor.

## ■ TESTING DIODES/BUZZERS AND CONTINUITY

### NOTE

To avoid damage to the instrument or the device under test, turn off all power to the circuit under test and fully discharge all high-voltage capacitors before measuring diodes or buzzers.

- Rotate the rotary knob [08] to face the  $\rightarrow \bullet \rightarrow$  measurement mode.

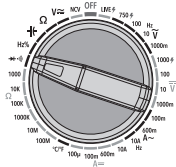

- Connect the black measurement probe to the COM input terminal [12] and the red probe to the V input terminal [11].

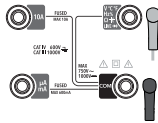

- Use the other ends of the measurement probes on the two terminals of the object to be tested.
- For diodes, place the red and black measurement probes at the positive and negative terminals of the diode respectively. The forward bias value of the diode under test will be displayed on the main display line [P]. If the polarity of the probes/diodes is reversed, the instrument will display "OL".

If the resistance of the circuit is less than about 100MΩ, the instrument will automatically switch to the continuity measurement mode.

If the resistance is more than 15Ω, the instrument will switch to continuity measurement mode and the indicator light (green)

will turn on and the buzzer will make a continuous sound. Between 15Ω~30Ω the indicator light (green) will flash and the buzzer will beep continuously.

## ■ MEASURING CAPACITANCE

### NOTE

To avoid damage to the instrument or the device under test, turn off all power to the circuit under test and fully discharge all high-voltage capacitors before measuring capacity. The DC voltage mode can be used to make sure that everything has been discharged.

- Rotate the rotary knob [08] to face the capacitance  $\text{—} \cap \text{—}$  measurement mode.

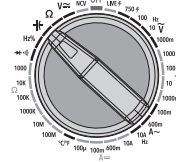

Connect the black measurement probe to the COM input terminal [12] and the red probe to the V input terminal [11].

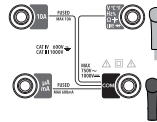

- Use the other ends of the measurement probes to measure the capacitance value of the object to be tested. The result will be shown on the display [03].

#### NOTE

When measuring large capacitance values, it takes a few moments to stabilize the reading.

Pay attention to the corresponding polarities of the subject and instrument to avoid any damage to the instrument.

### ■ MEASURING FREQUENCY

#### NOTE

Do not measure any frequencies of voltage above 250V AC or DC RMS to prevent electric shock and/or damage to the instrument.

- Rotate the rotary knob [08] to face the frequency (Hz%) measurement mode.

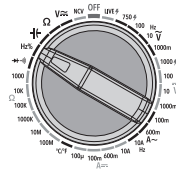

- Connect the black measurement probe to the COM input terminal [12] and the red probe to the V input terminal [11].

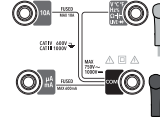

- Use the other ends of the measurement probes to measure the frequency value of the circuit to be tested.
- Both the frequency and duty cycle values are displayed simultaneously on the display [03].

### ■ MEASURING CURRENT

#### NOTE

When the open-circuit voltage to the grounding exceeds 250V, do NOT attempt to make current measurements. If the fuse is burnt out during the measurement, you may cause damage to you and/or the instrument.

When measuring, use the correct input socket, function gear and range.

When the measurement probe is plugged into the current input socket, do not connect the other terminal of the measurement probe in parallel to any circuit.



- Rotate the rotary knob [08] to face the appropriate range in the AC (A~) or DC (A $\overline{\text{---}}$ ) measurement mode.

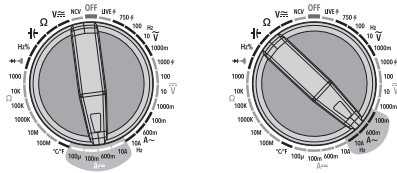

#### MEASUREMENTS UNDER 600mA

- Connect the black measurement probe to the COM input terminal [12] and the red probe to the  $\mu\text{A}/\text{mA}$  input terminal [10].

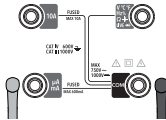

#### MEASUREMENTS BETWEEN 600mA AND 10A

- Connect the black measurement probe to the COM input terminal [12] and the red probe to the 10A input terminal [09].

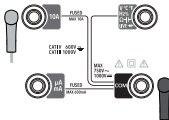

- Disconnect the circuit to be tested.
- Connect the black measurement probe to the terminal of the disconnected circuit with the lower voltage.
- Connect the red measurement probe to the terminal with the higher voltage.
- Connect the power to the circuit and the reading will be displayed on the display [03].

In the AC current gear, the display shows both current and frequency. If the display shows "OL", it means the input exceeded the selected range, in that case turn the rotary knob [08] to a higher range and measure again.

#### NCV TEST

- Rotate the rotary knob [08] to face the NCV measurement mode.

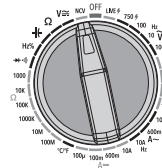

- Hold the NCV sensor [01] near the test area.
- If the instrument detects AC voltage, it will light up the signal strength indicator [02] according to the detected signal strength.
- Sensing low voltage, the indicator [02] will light up green and the display [03] will show "-- L".

- Sensing high voltage, two indicators [02] will light up red and the display [03] will show "-- H". The buzzer will also sound an alarm.

#### NOTE

Even if no indication is shown, voltage may still exist, do not rely on non-contact voltage detectors to determine if a wire has voltage. Detection operations may be affected by many factors such as socket design, insulation etc...

The voltage sensing indicator may also light up due to the presence of induced voltage

Interfering sources in the environment such as flashing lights, may trigger NCV detection by mistake.

#### ■ LIVE LINE - NEUTRAL LINE DISTINGUISH

- Rotate the rotary knob [08] to face the Live measurement mode.

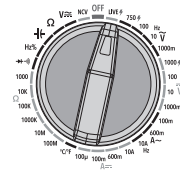

- Connect the red measurement probe to the V input socket [11].
- Insert a single measurement probe in to the power socket L jack or close the the live wire.

If the instrument detects AC voltage, it will judge whether the voltage is a live wire according to the detected strength. If it is judged to be a live line; the display [03] will read "LIVE" and the green indicator light [02] will be on. and the buzzer will sound an alarm with alternating intensities.

#### ■ TEMPERATURE MEASUREMENT

- Rotate the rotary knob [08] to face the °C/°F measurement mode and the room temperature will be shown on the display [03].

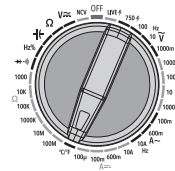

- You can also connect the red plug of the thermocouple in to the °C input socket [11] and the black plug in the COM socket [12].
- Use the tiny probe on the other end to measure the temperature of any subject.

#### NOTE

The default unit is °C, to change this, simply press the Select button [04].

## TECHNICAL SPECIFICATIONS

### ■ CONDITIONS FOR USAGE

MODEL	MM6500
Protection	600V CAT. IV and 1000V CAT. III
Pollution degree	Degree 2
Operational altitude	< 2000 m
Operating environment	Temperature: 0°C - 40°C Relative humidity: <80%
Storage environment	Temperature: -10°C - 60°C Remove battery before long time storage
Temperature coefficient	0.1 accuracy <18 °C or >28°C
Max voltage between terminal and ground	1000V DC or 750 AC RMS
Fuse tube protection	-mA mode: fuse tube FF 600mA/250V -A mode: fuse tube FF 10A/250V
Conversion rate	3 times / second
Power supply	2 x 1.5V AA Batteries
Dimensions	185 x 88 x 52 mm
Weighth	350g inc. battery

### ■ PRECISION INDEX

#### — DC VOLTAGE

RANGE	RESOLUTION	ACCURACY
999.9mV	0.1mV	± 0.5% reading + 3 digits
9.999V	1mV	
99.99V	10mV	
999.9V	100mV	

Input impedance: 10M

Max input: 1000V DC or 750V AC RMS

#### — AC VOLTAGE

RANGE	RESOLUTION	ACCURACY
999.9mV	0.1mV	± 0.8% reading + 3 digits
9.999V	1mV	
99.99V	10mV	
999.9V	100mV	± 1 % reading + 5 digits

Input impedance: 10M

Max input: 1000V DC or 750V AC RMS

Frequency response: 40Hz-1KHz true RMS  
(VFC: 2KHz attenuation -3dB)

## \_\_\_ FREQUENCY

RANGE	RESOLUTION	ACCURACY
9.999Hz	0.001Hz	± 1.0% reading + 3 digits
99.99Hz	0.01Hz	
999.9Hz	0.1Hz	
9.999KHz	0.001kHz	
99.99KHz	0.01kHz	
999.9KHz	0.1kHz	
9.999MHz	0.001MHz	

Range of input voltage: 200mV - 10V AC RMS

Overload protection: 600V AC/DC

## \_\_\_ DIODE

FUNCTION	RANGE	ACCURACY	
Diode test	0.15V - 3V	0.001V	Forward DC current: about 1mA. Open-circuit voltage: ± 3.2V The display shows an approximation of the forward voltage drop of the diode.

Overload protection: 600V AC/DC

## \_\_\_ BUZZER AND CONTINUITY TEST

FUNCTION	RANGE	ACCURACY	DESCRIPTION	TEST CONDITION
	100Ω	1Ω	Built-in buzzer sounds and the green light [02] turns on when resistance < 15Ω. Between 15 and 30Ω the buzzer beeps and the green indicator light [02] flashes.	Open-circuit voltage: ±1V

Overload protection: 600V AC/DC

## \_\_\_ CAPACITANCE

RANGE	RESOLUTION	ACCURACY
9.999nF	0.001nF	± 4.0% reading + 3 digits
99.99nF	0.01nF	
999.9nF	0.1nF	
9.999μF	1nF	
99.99μF	10nF	
999.9μF	100nF	
9.999mF	1μF	
99.99mF	10μF	± 5.0% reading + 3 digits

Overload protection: 600V AC/DC

## \_\_\_ DIRECT CURRENT

RANGE	RESOLUTION	ACCURACY
99.99A	0.01A	± 0.8% reading + 3 digits
999.9mA	0.01mA	
600mA	0.1mA	
10.00A	10mA	± 1.2% reading + 3 digits

Max input mA input: 600mA DC or AC RMS

Max input 10A input: 10A DC or AC RMS

When the measured current is greater than 5A, the continuous measurement time may be no longer than 10 seconds. After this measurement, no new measurements should be made for at least 1 minute.

## \_\_\_ ALTERNATING CURRENT

RANGE	RESOLUTION	ACCURACY
99.99mA	0.01mA	± 1.0% reading + 3 digits
600mA	0.1mA	
10.00A	10mA	± 1.5% reading + 3 digits

Max input mA input: 600mA DC or AC RMS

Max input 10A input: 10A DC or AC RMS

When the measured current is greater than 5A, the continuous measurement time may be no longer than 15 seconds. After this measurement, no new measurements should be made for at least 1 minute.

Frequency response: 40Hz-1kHz, true RMS

## \_\_\_ TEMPERATURE

RANGE	RESOLUTION	ACCURACY
-20°C ~ 1000°C	1°C	± 1.0% reading + 3 digits
-4°F ~ 1832°F	1°F	

Overload protection: 600V AC/DC



## DECLARATION OF CONFORMITY

Futech (Belgium) declares under its own responsibility that this device:

- MM6500 Multimeter

is in conformity with the standards

- EN61326-1:2013
- EN61326-2-2:2013
- EN61000-3-2:2014
- EN61000-3-3:2013
- EN61010-1:2010
- EN61010-2-030:2010
- EN61010-2-033:2012

under directive  
EMC - 2014/30/EU  
EMC - 2014/35/EU

Lier, Belgium,  
March 30, 2023  
Patrick WäUTERS

Potential misprints are reserved. Images used are not strict. All features, functionality and other product specifications are subject to change without notice or obligation.



## NOTES



# USER MANUAL

other languages:



DA DANSK



DE DEUTSCH



ES ESPAÑOL



ET EESTI KEEL



FI SUOMEN KIELI



FR FRANÇAIS



IS ÍSLENSKA



IT ITALIANO



NL NEDERLANDS



NO NORSK



PT PORTUGUÊS



SL SLOVENŠČINA



SV SVENSKA



Facebook  
@futechtools



LinkedIn  
futechtools



World Wide Web  
futech-easy.com



YouTube  
@futechtools